

# First Army

## Welcome Foreign Military Attaches

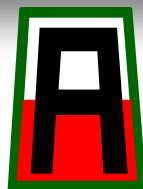

*First Army*



**7 March 2013**  
**MG Kevin R. Wendel**



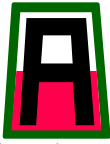

# Mission Statement



First Army **advises, assists and trains** Reserve Component **units during pre-mobilization periods**. Conducts mobilization, training support, readiness validation, and deployment of alerted forces. **Executes demobilization of Reserve Component forces** in accordance with Department of the Army, and FORSCOM directives. Provides trained and ready forces in support of the Army Force Generation model. As directed, provides training to Joint, Combined, Interagency, and Active Army Forces.

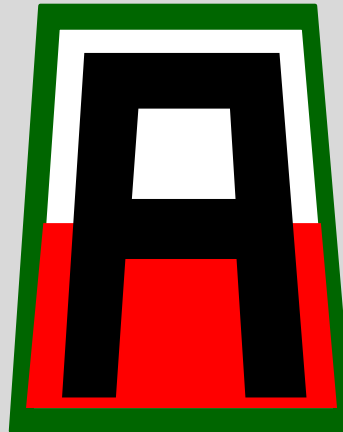

UNCLASSIFIED



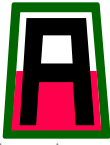

# Bottom Line



First Army serves as FORSCOM's Executing Agent for:

- Mobilization Operations in the Continental United States (CONUS) ... plus Puerto Rico & the US Virgin Islands
- Active Component (AC) to Reserve Component (RC) training support in CONUS ... plus Puerto Rico & the US Virgin Islands
- Validating the Operational Reserve for Distributed Non-Deploying Units and Regionally Aligned Forces (RAF) Employment

First Army provides trained and ready forces covering the full range of military operations responsive to the Combatant Commanders. We are the Army's enabler, supporting the long-term readiness of our Nation's Reserve Component capabilities, whether current Deploying Rotational Forces, or Rotational Regionally Aligned and Operational Support Forces preparing to meet our Nation's Contingencies.

***Army National Guard***



***US Army Reserve***



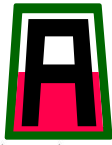

# Regional Support

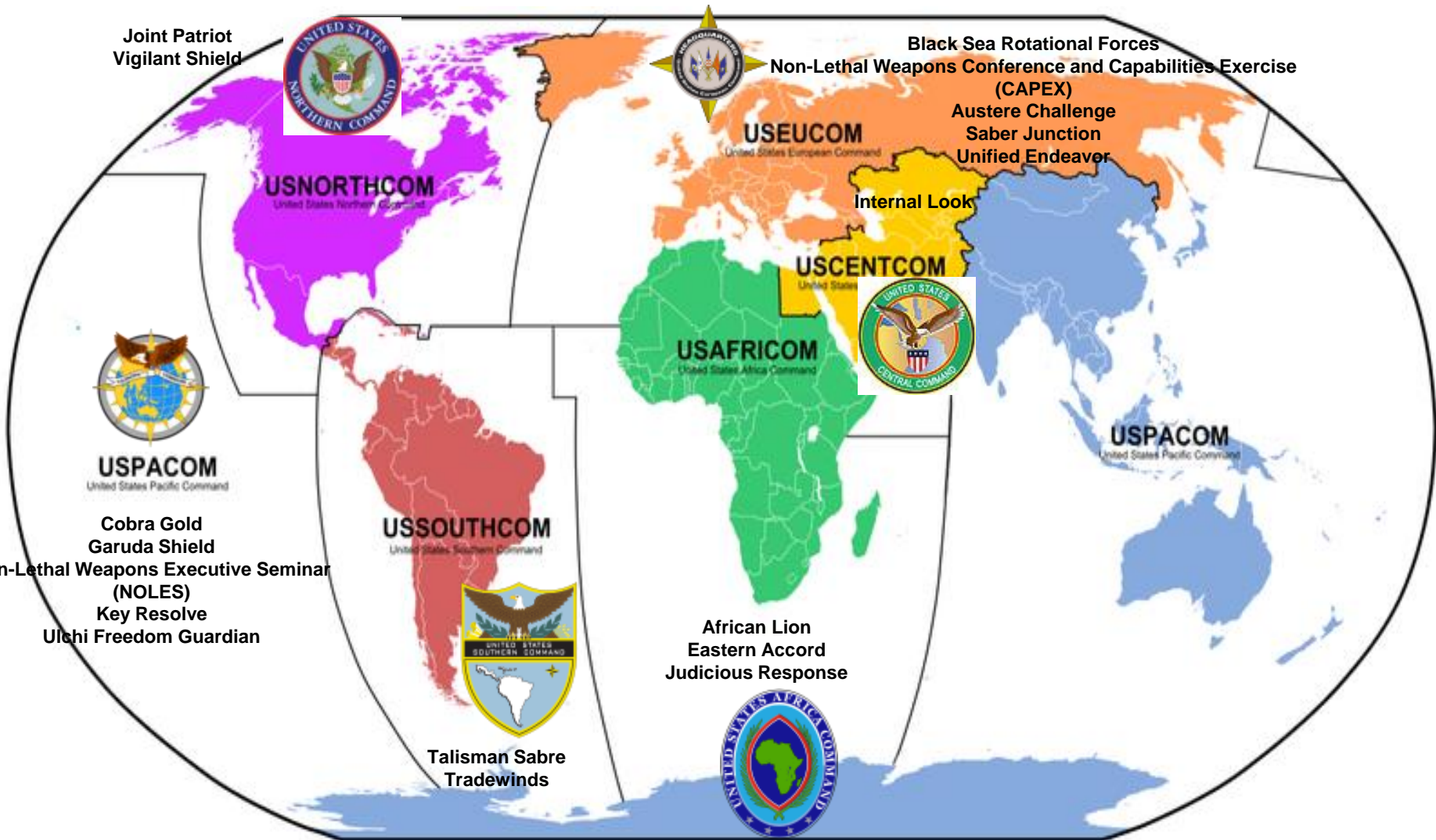



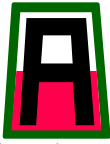

# State Partnership Program (SPP)



## 64 State Partnerships

### USEUCOM - 22

Alabama / Romania (1993)  
 California / Ukraine (1993)  
 Colorado / Slovenia (1993)  
 Georgia / Georgia (1994)  
 Illinois / Poland (1993)  
 Indiana / Slovakia (1993)  
 Iowa / Kosovo (2011)  
 Kansas / Armenia (2002)  
 Maine / Montenegro (2006)  
 Maryland / Estonia (1993)  
 Maryland / Bosnia (2003)  
 Michigan / Latvia (1993)  
 Minnesota / Croatia (1996)  
 New Jersey / Albania (2001)  
 North Carolina / Moldova (1996)  
 Ohio / Hungary (1993)  
 Ohio / Serbia (2005)  
 Oklahoma / Azerbaijan (2002)  
 Pennsylvania / Lithuania (1993)  
 Tennessee / Bulgaria (1993)  
 Texas, Neb / Czech Republic (1993)  
 Vermont / Macedonia (1993)

### USAFRICOM - 8

California / Nigeria (2006)  
 New York / South Africa (2003)  
 North Carolina / Botswana (2008)  
 North Dakota / Ghana (2004)  
 Michigan / Liberia (2009)  
 Utah / Morocco (2003)  
 Vermont / Senegal (2008)  
 Wyoming / Tunisia (2004)

### USCENTCOM - 5

Arizona / Kazakhstan (1993)  
 Colorado / Jordan (2004)  
 Mississippi / Uzbekistan (2012)  
 Montana / Kyrgyzstan (1996)  
 Virginia / Tajikistan (2003)

### USPACOM - 6

Alaska / Mongolia (2003)  
 Hawaii, Guam / Philippines (2000)  
 Hawaii / Indonesia (2006)  
 Idaho / Cambodia (2009)  
 Oregon / Bangladesh (2008)  
 Washington / Thailand (2002)

### USNORTHCOM - 1

Rhode Island / Bahamas (2005)

### USSOUTHCOM - 22

Arkansas / Guatemala (2002)  
 Connecticut / Uruguay (2000)  
 Delaware / Trinidad-Tobago (2004)  
 District of Columbia / Jamaica (1999)  
 Florida / Venezuela (1998)  
 Florida / Guyana (2003)  
 Florida, Virgin Is. / RSS (2006)  
 Kentucky / Ecuador (1996)  
 Louisiana / Belize (1996)  
 Louisiana / Haiti (2011)  
 Massachusetts / Paraguay (2001)  
 Mississippi / Bolivia (1999)  
 Missouri / Panama (1996)  
 New Hampshire / El Salvador (2000)  
 New Mexico / Costa Rica (2006)  
 Puerto Rico / Honduras (1998)  
 Puerto Rico / Dominican Rep. (2003)  
 South Carolina / Colombia (2012)  
 South Dakota / Suriname (2006)  
 Texas / Chile (2008)  
 West Virginia / Peru (1996)  
 Wisconsin / Nicaragua (2003)

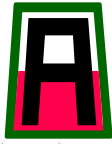

# Organizational Structure



## First Army

2 Divisions  
 16 Training Support Brigades  
 103 Training Support Battalions  
 AC Battalions = 42  
 RC Battalions = 61 (located throughout the US)

**LEGEND**

- Assigned
- OPCON
- ADCON
- Active
- Reserve
- ARNG

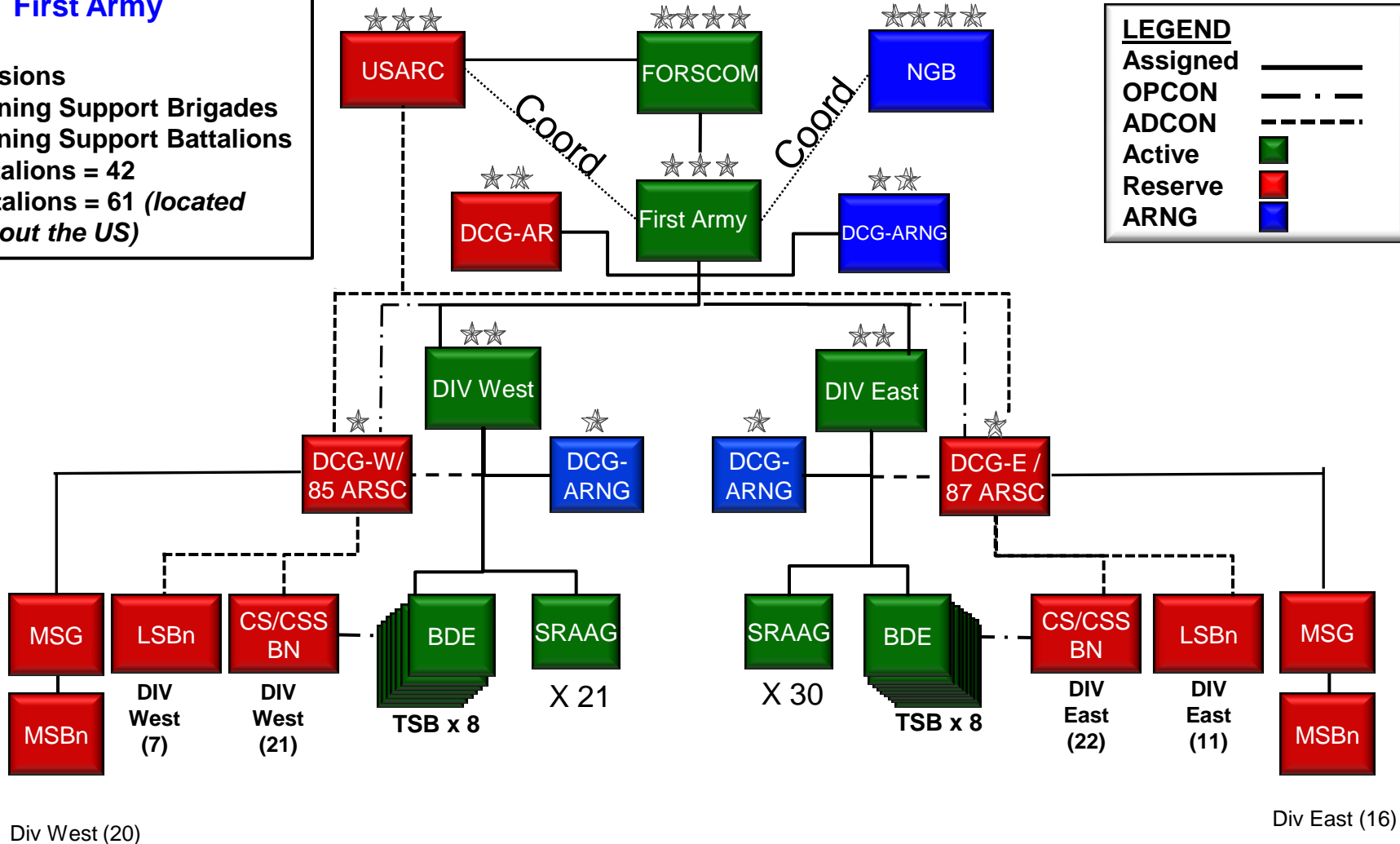

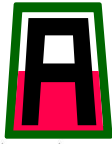

# What We Do and Where We Go...



## Mobilization

We Mobilize, Train, Validate, Deploy and Demobilize Reserve Component (RC) Units and Soldiers:

- When RC units/Soldiers are mobilized for Active Federal Service under Title 10 USC
- Upon Mobilization .... RC units and Soldiers are Attached to First Army
- First Army shares Administrative Control (ADCON) of mobilized RC units/Soldiers with the supporting Installation/Garrison

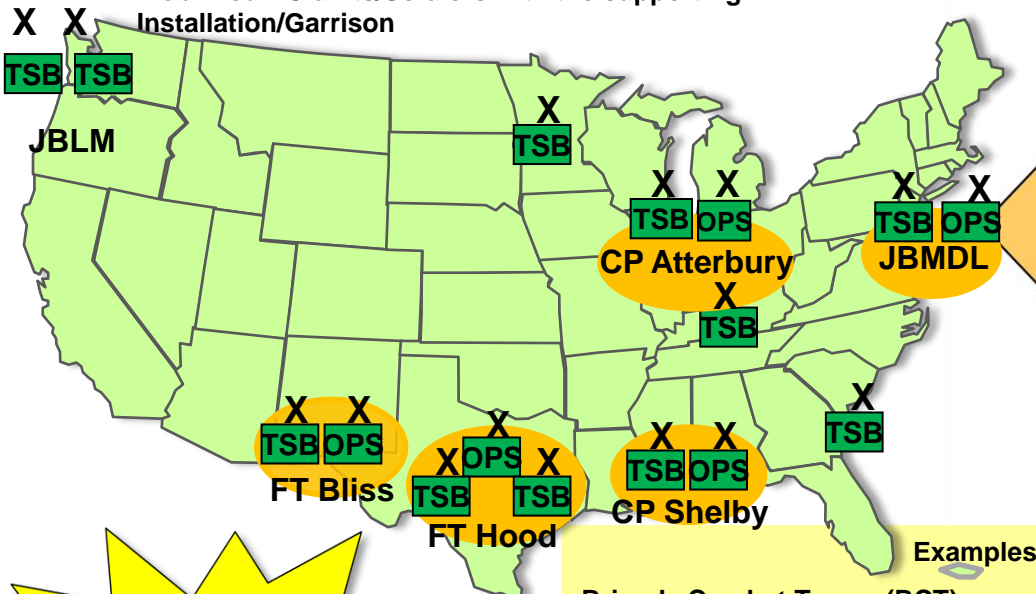

Examples

- Brigade Combat Teams (BCT),
- Expeditionary Sustainment Commands (ESC)
- Aviation Battalions/Companies, Signal Brigades
- Provincial Reconstruction Teams (PRT)
- NATO Training Mission – Afghanistan (NTM-A)
- Engineer Route Clearance Companies/Platoons
- Security Force Advisory Brigades (SFAB)
- Security Force Advisory and Assistance Teams (SFAAT)

**Multi-Component**  
We are who we train ....

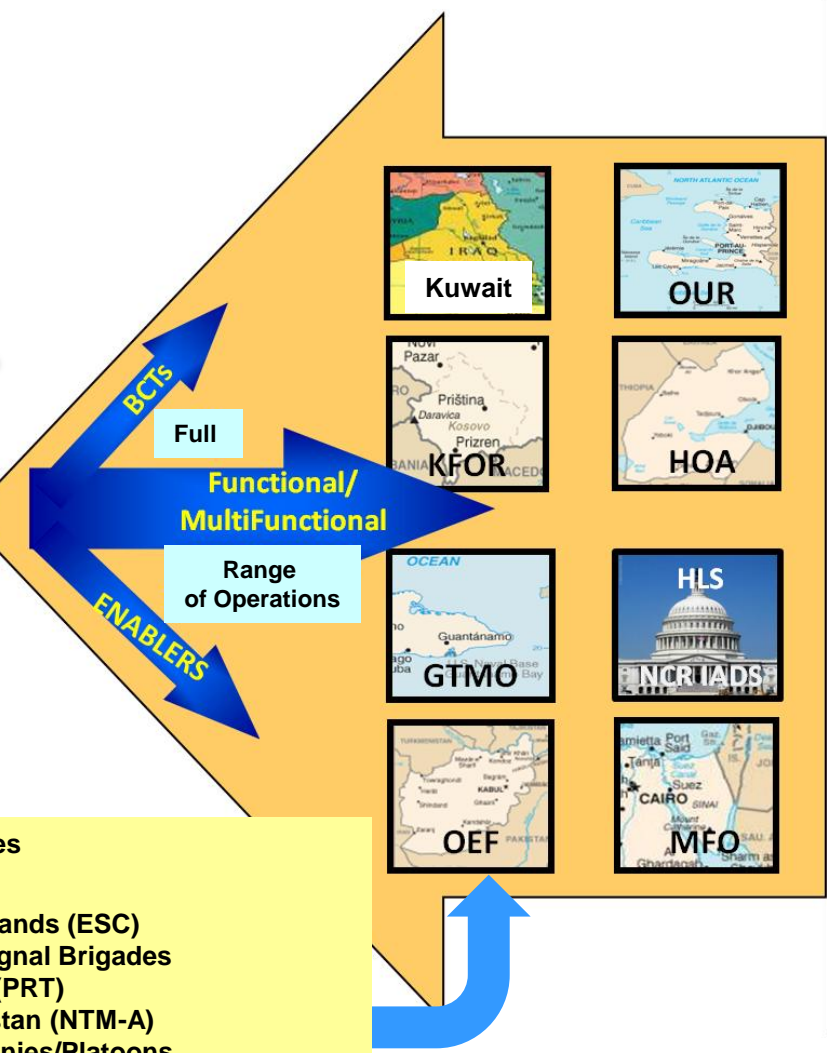

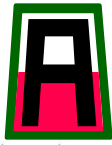

# Training Support to RC Collective Training...

## *Current Collective Training Strategy*



...tailored to meet the needs of our Combatant Commanders

➤ *How do we Sustain Readiness?*

- Combat Training Centers
- Division/Brigade War Fighter Exercises
- Exportable Combat Training Capability
- Warrior Exercises
- Combat Support Training Exercises
- Command Post Exercises
- Regionally Aligned Forces

➤ *Distributed Regional Collective Training Centers*

➤ *Integrate Live – Virtual – Constructive - Gaming*

- University of Southern California, Institute for Creative Technology

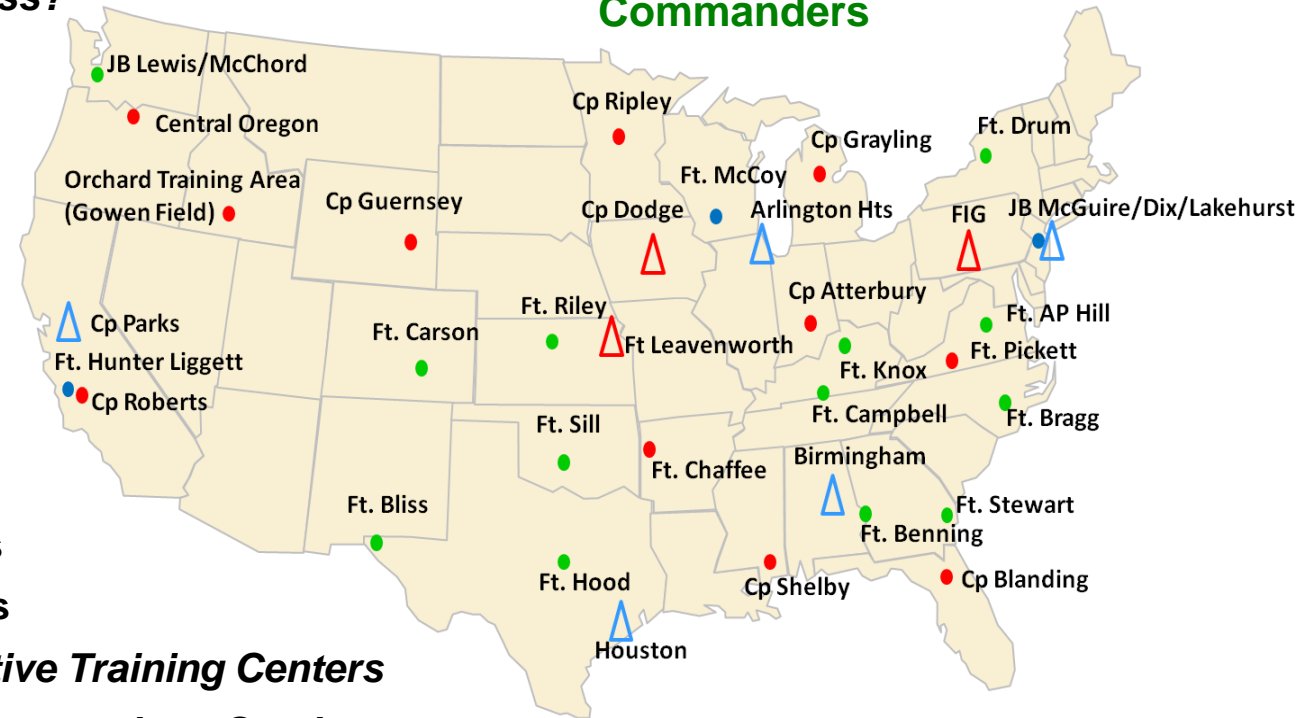

**Soldiers participating in Exercises**  
 FY 13 – 51.8 K  
 FY 14 – 58.8 K

***Collective Training Exercises are the lynch-pin for building and sustaining RC readiness***





## DIVISION EAST UNIQUE MISSION SETS



### ***Unique Mission Sets that Division East conducts and provides:***

- ***Kosovo (KFOR) (Camp Atterbury, IN)***
- ***Agriculture Development Team (ADT) (Camp Atterbury, IN)***
- ***Multi-National Force and Observer (MFO) Camp Atterbury, IN)***
- ***Provincial Reconstruction Teams (PRT) (Camp Atterbury, IN)***
- ***Horn of Africa (HOA) (Camp Atterbury, IN)***
  
- ***Security Force Assistance Advisor Teams (SFA AT) (Camp Shelby, MS)***
  
- ***Brigade Combat Team (BCT) (Camp Shelby, MS)***
  
- ***NATO Training Mission Afghanistan (NTM-A) (Joint Base McGuire-Dix-Lakehurst, NJ)***
  
- ***Contingency Expeditionary Forces (CEF) (Multiple locations)***

# DIVISION WEST

## UNIQUE MISSION SETS



### ***Unique Mission Sets that Division West conducts and provides:***

- ***Aviation Training (Ft Hood, TX)***
- ***Medical Training (Ft Hood & Ft Bliss, TX)***
- ***Sustainment Training (Ft Hood, TX)***
- ***Detainee Operations Training (Ft Bliss, TX)***
- ***Route Clearance Training (to include other EN units) (Ft Bliss, TX)***
- ***National Capitol Region - Integrated Air Defense System Training (Ft Bliss, TX)***
- ***Joint Services Training Operations (Ft Bliss, TX)***

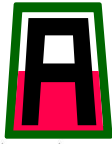

# ARFORGEN Training Model

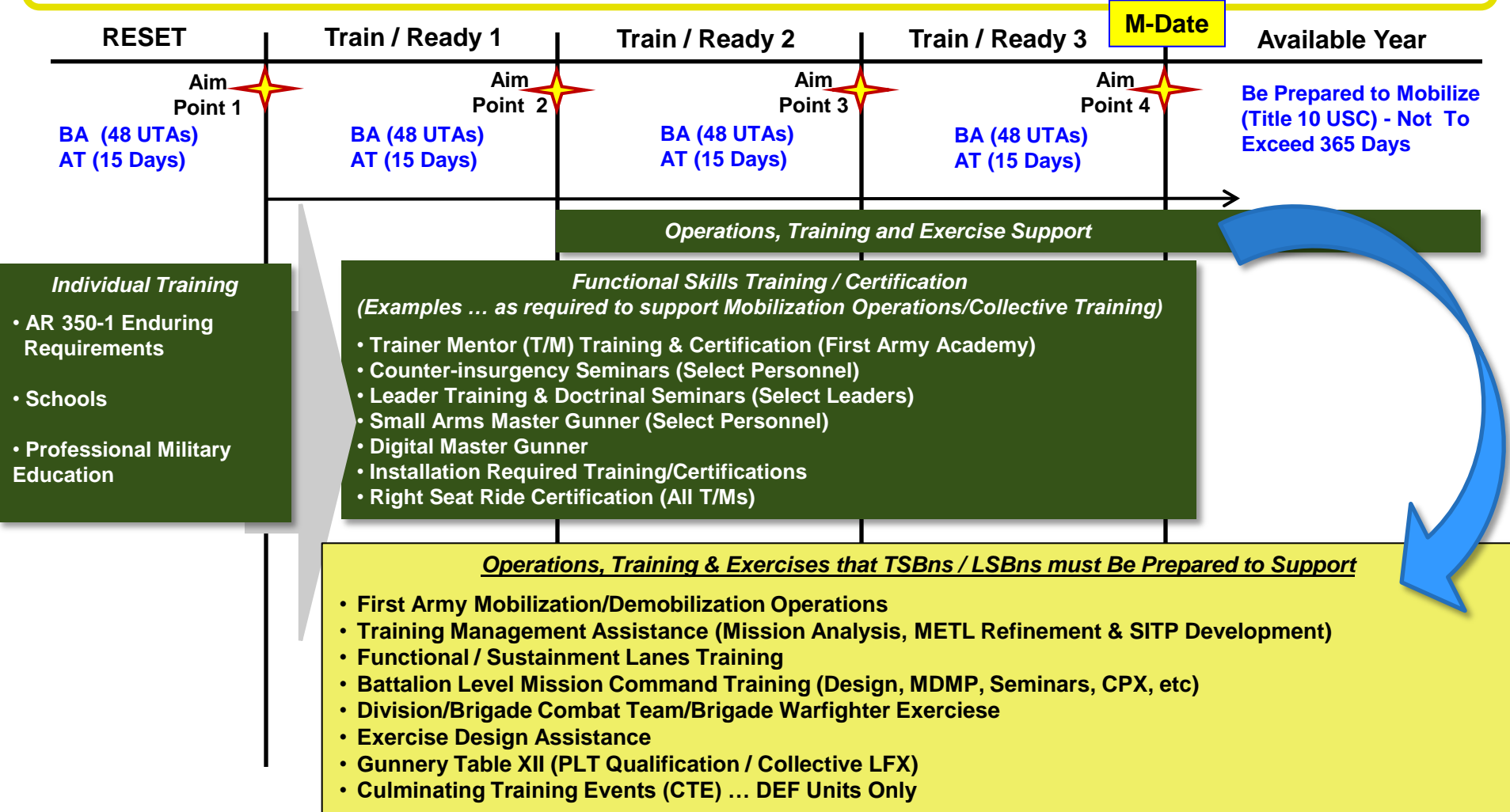

BA = Battle Assembly  
 AT = Annual Training  
 UTA = Unit Training Assembly



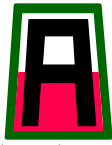

# Single Integrated Training Plan



## Example

01 MAR

08 APR

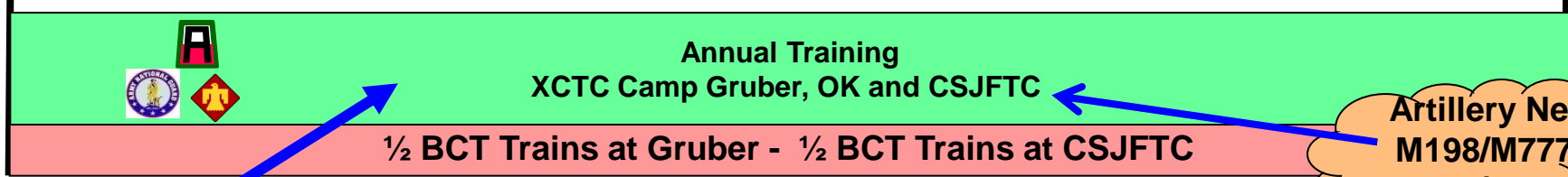

### Pre and Post Mobilization Model

#### Annual Training - CSJFTC

- ✓ CIED
- ✓ IWQ (M9, M4, M203)
- ✓ TSIRT/ TSLIT
- ✓ Squad LFX
- ✓ CSWQ
- ✓ CLS
- ✓ MRAP Operator/Maintenance

Leader Training

Training Enablers  
MTTs

#### 65 Days - Post MOB Training

- ✓ COIN STX
- ✓ CIED/ EOF
- ✓ GTCST/GT T VIII-XI (GT centric units)
- ✓ Urban Operations and UO LF
- ✓ MRAP Drivers and Maintenance
- ✓ CPX (BDE) and FTX (BN)

27 MAR 11

15 MAY 11

Available to Deploy  
11-29 JUN 11

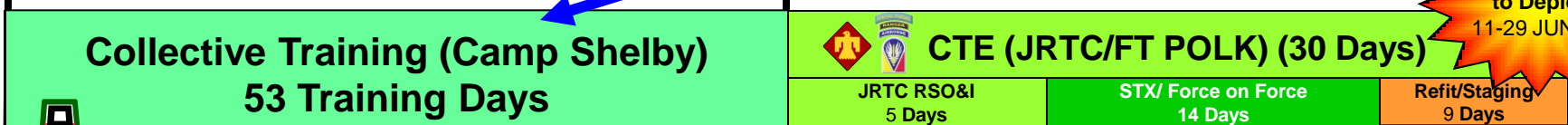

### 95 Days Deployment Training

# Requirements-Based Demobilization Model

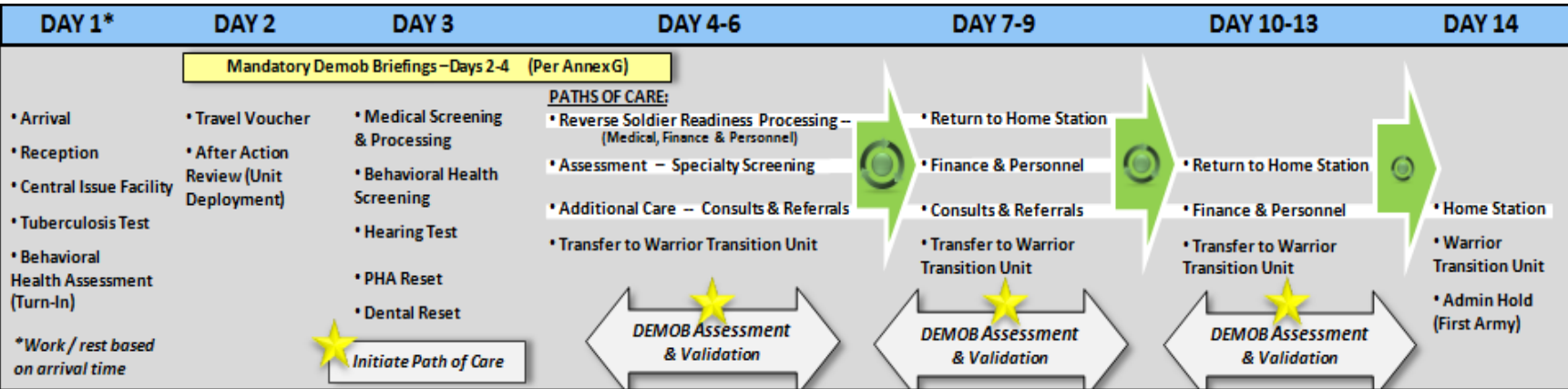
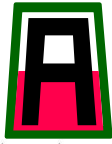

## Concept of Operations

- Engage Unit Leaders in Demob Planning, Prep & Execution from Joint Assessment (JA) to REFRAID
- Establish Deployment Support Cells (DSC) at Demob Stations (DMS)
- Continuously Assess & Refine Soldier's:
  - "Path of Care" requirements at DMS
  - "Continuity of Care" requirements at HS
- Iterate Demob Validation & Assessment

**Flexible to assess & address Soldier care, benefits & entitlements**

## VOW/TAP Implementation

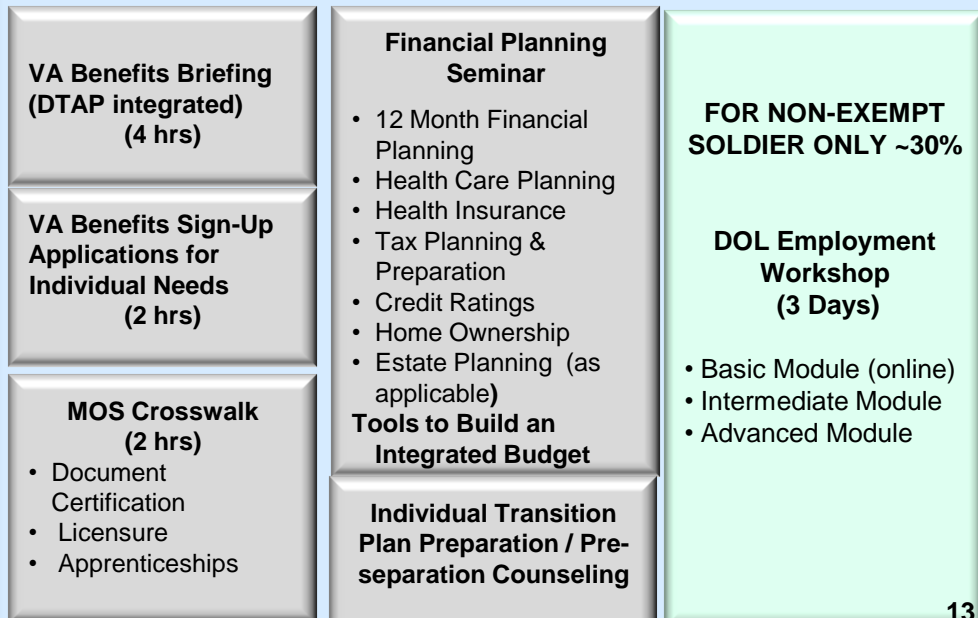



# Mission Load 2013-2014

*(Mobilization & Demobilization)*



## Current Projections (2013)

- Mobilization Load - 38,000
- Demobilization Throughput - 36,900
- **Total Mission Load : 74,900**

## Current Projections (2014)

- Projected requirements based on FY14 Army Sourcing Requirements
- Mobilization Load - 31,000
- Demobilization Throughput - 29,600
- **Total Mission Load: 60,600**





# Regionally Aligned Forces



**Purpose:** Regionally Aligned Forces provide the COCOM with up to Joint Task Force capable headquarters with scalable, tailorable capabilities to enable him to shape the environment.

**Forces:** Those Army *units*:

- **assigned** to combatant commands;
- **allocated** to a combatant command; and
- those *capabilities* **distributed** and *prepared by the Army* for COCOM regional missions.

**Includes:** Army Total Force organizations and capabilities which are:

- forward stationed;
- operating in a combatant command area of responsibility; and
- supporting from outside the area of responsibility. (reach-back; support from outside the AOR)

**Mission Set:** Regional missions are driven by COCOM requirements, & includes:

- an understanding of the cultures, geography, languages, and militaries of the countries where they are most likely to be employed; and
- expertise in how to impart military knowledge and skills to others.

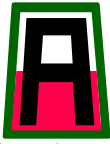

# Army Through 2020 and Beyond

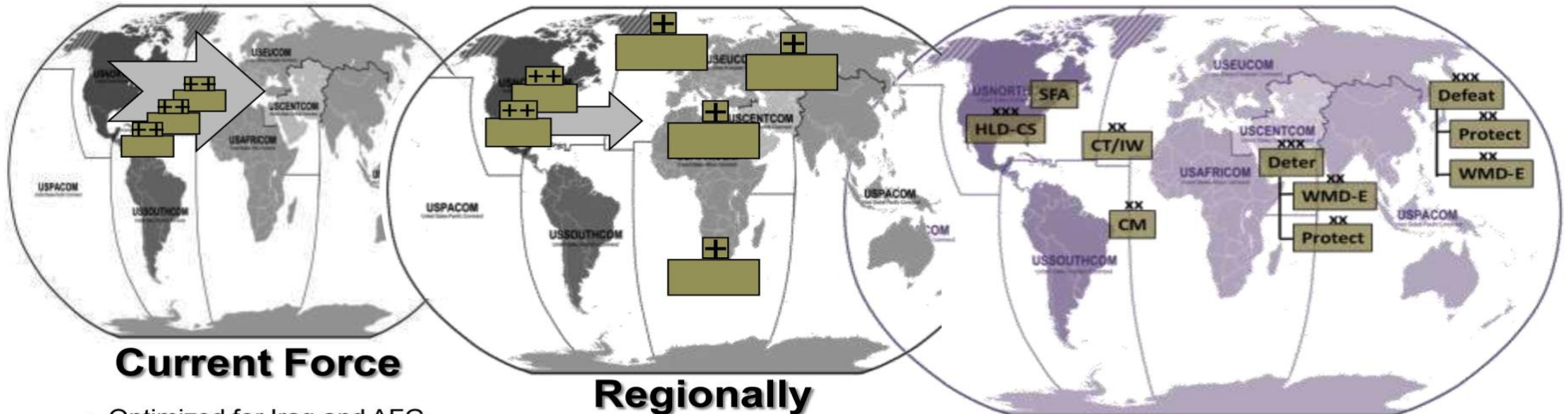

## Current Force

- Optimized for Iraq and AFG
- Modular

## Regionally Aligned Force

Improved ability to respond to GCC requirements

## Mission Tailored, Regionally Aligned Force

Optimized for a broader range of requirements



*The Army will build on current capabilities to improve responsiveness, agility and precision for a range of contingencies*

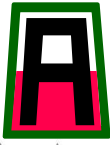

# Bottom Line



**First Army provides trained and ready forces covering the full range of military operations responsive to the Combatant Commanders. We are the Army's enabler, supporting the long-term readiness of our Nation's Reserve Component capabilities, whether current Deploying Rotational Forces, or Rotational Regionally Aligned and Operational Support Forces preparing to meet our Nation's Contingencies.**

***Army National Guard***



***US Army Reserve***







# Questions/Discussion